

Fakro Sp. z.o.o.

ul. Węgierska 144a
33-300 Nowy Sącz
Poland

Tel: 00 18 48 444 0444 Fax: 00 18 48 444 0333
e-mail: sales@fakrogb.com
website: www.fakro.co.uk



Agrément Certificate
02/3944
Product Sheet 2

FAKRO ROOF WINDOWS

FAKRO FPP PRESELECT TOP-HUNG ROOF WINDOWS

PRODUCT SCOPE AND SUMMARY OF CERTIFICATE

This Certificate relates to Fakro FPP preSelect Top-hung Roof Windows, for use on roofs of domestic and commercial buildings with a pitch between 15° and 55°, to provide natural light and ventilation.

AGRÉMENT CERTIFICATION INCLUDES:

- factors relating to compliance with Building Regulations where applicable
- factors relating to additional non-regulatory information where applicable
- independently verified technical specification
- assessment criteria and technical investigations
- design considerations
- installation guidance
- regular surveillance of production
- formal three-yearly review.



KEY FACTORS ASSESSED

Thermal insulation — the thermal transmittance value (U value) of an FPP preSelect top-hung roof window was measured by the Hot Box Method according to BS EN ISO 12567-2 : 2005 (see section 5).

Weathertightness — the products can be used in the exposure situations described in this Certificate (see section 6).

Structural stability — the products can be selected to have adequate resistance to wind loads (see section 7).

Ventilation — the products can provide rapid ventilation and background ventilation (see section 8).

Behaviour in relation to fire — the glazing used in the windows can be regarded as non-combustible material. Windows can be used for emergency egress (see section 9).

Durability — the life of the products is expected to be at least equal to conventional timber windows. Any slight external colour change or surface dulling of the aluminium covers that might occur will be uniform over the visible surfaces of the windows (see section 10).

The BBA has awarded this Agrément Certificate to the company named above for the products described herein. The products have been assessed by the BBA as being fit for their intended use provided they are installed, used and maintained as set out in this Certificate.

On behalf of the British Board of Agrément

Chris Hunt
Head of Approvals — Physics

Greg Cooper
Chief Executive

Date of First issue: 13 July 2009

The BBA is a UKAS accredited certification body — Number 113. The schedule of the current scope of accreditation for product certification is available in pdf format via the UKAS link on the BBA website at www.bbacerts.co.uk

Readers are advised to check the validity and latest issue number of this Agrément Certificate by either referring to the BBA website or contacting the BBA direct.

British Board of Agrément
Bucknalls Lane
Garston, Watford
Herts WD25 9BA

©2009

tel: 01923 665300
fax: 01923 665301
e-mail: mail@bba.star.co.uk
website: www.bbacerts.co.uk

Regulations

In the opinion of the BBA, Fakro FPP preSelect Top-hung Roof Windows, if used in accordance with the provisions of this Certificate, will meet or contribute to meeting the relevant requirements of the following Building Regulations:



The Building Regulations 2000 (as amended) (England and Wales)

Requirement:	A1	Loading
Comment:		The products will have sufficient strength and stiffness to sustain the imposed loads. See sections 7.1 and 7.2 of this Certificate.
Requirement:	B1	Means of warning and escape
Comment:		Windows of an appropriate size can be used as an escape route from floors not more than 4.5 m above ground level. See section 9.4 of this Certificate.
Requirement:	B2	Internal fire spread (linings)
Comment:		The glazing used in the products can be regarded as non-combustible material and, therefore, can be taken as having a Class 0 classification. See section 9.1 of this Certificate.
Requirement:	B4(2)	External fire spread
Comment:		When used in roof windows, unwired glass at least 4 mm thick can be regarded as having an AA designation. See section 9.2 of this Certificate.
Requirement:	C2(b)	Resistance to moisture
Comment:		The windows will resist weather ingress. See sections 6.1 and 6.2 of this Certificate.
Requirement:	C2(c)	Resistance to moisture
Comment:		The windows can contribute to satisfying this Requirement. Vents will provide airflow to alleviate surface condensation. See section 11 of this Certificate.
Requirement:	F1	Means of ventilation
Comment:		In calculating the contribution of the products to natural purge ventilation, the area of opening given in section 8.1 of this Certificate should be related to floor area as set out in Approved Document F. Background ventilation is provided by vents incorporated in the windows. See sections 8.2 and 8.3 of this Certificate.
Requirement:	L1(a)	Conservation of fuel and power
Comment:		See sections 5.1 and 5.2 of this Certificate.
Requirement:	N1	Protection against impact
Comment:		Glazing less than 800 mm above floor level should meet the requirements of Requirement N1 or should comply with the requirements of BS EN 12600 : 2002. See section 12.2 of this Certificate.
Requirement:	N3	Safe opening and closing of windows etc
Comment:		In buildings other than dwellings, windows which can be opened by people in or about the building should be constructed or equipped so that they can be opened, closed or adjusted safely. See section 12.1 of this Certificate.
Requirement:	N4	Safe access for cleaning windows etc
Comment:		In buildings other than dwellings, this Requirement can be met. See section 15.4 of this Certificate.
Requirement:	Regulation 7	Materials and workmanship
Comment:		The products are acceptable. See sections 16.1, 16.2, 16.5 and 16.6 and the <i>Installation</i> part of this Certificate.



The Building (Scotland) Regulations 2004 (as amended)

Regulation:	8(1)(2)	Fitness and durability of materials and workmanship
Comment:		The products satisfy the requirements of this Regulation. See sections 15.1 to 15.3, 16.1, 16.2, 16.5 and 16.6 and the <i>Installation</i> part of this Certificate.
Regulation:	9	Building standards — construction
Standard:	1.1(b)	Structure
Comment:		The products will have sufficient strength and stiffness to sustain the imposed loads, with reference to clauses 1.1.1 ⁽¹⁾⁽²⁾ , 1.1.2 ⁽¹⁾⁽²⁾ and 1.1.3 ⁽¹⁾⁽²⁾ . See sections 7.1 and 7.2 of this Certificate.
Standard:	2.5	Internal linings
Comment:		The glazing, as part of the ceiling lining is non-combustible, with reference to clause 2.5.1 ⁽¹⁾⁽²⁾ . See section 9.1 of this Certificate.
Standard:	2.8	Spread from neighbouring buildings
Comment:		When used in roof windows, glass at least 4 mm thick is classified as 'low vulnerability' material, with reference to clause 2.8.1 ⁽¹⁾⁽²⁾ . See section 9.3 of this Certificate.
Standard:	2.9	Escape
Comment:		Windows of an appropriate size can be used as an escape route from an apartment on an upper storey at a height of not more than 4.5 m. See section 9.4 of this Certificate.
Standard:	3.10	Precipitation
Comment:		The products will resist weather ingress, with reference to clause 3.10.1 ⁽¹⁾⁽²⁾ . See sections 6.1 and 6.2 of this Certificate.
Standard:	3.14	Ventilation
Comment:		In calculating the contribution of the windows to natural ventilation, with reference to clause 3.14.2 ⁽¹⁾⁽²⁾ to this Standard, see section 8.1 of this Certificate. Trickle ventilation, with reference to clauses 3.14.3 ⁽²⁾

Standard:	3.15	and 3.14.5 ⁽¹⁾⁽²⁾ , is provided by vents incorporated in the windows. See sections 8.2 and 8.3 of this Certificate.
Comment:		Condensation The windows can contribute to satisfying this Standard, with reference to clauses 3.15.1 ⁽¹⁾ and 3.15.4 ⁽¹⁾ . See section 11 of this Certificate. Vents, where fitted, will provide airflow to alleviate surface condensation, with reference to clause 3.15.4 ⁽¹⁾ . See section 11 of this Certificate.
Standard:	3.16	Natural lighting
Comment:		In calculating the contribution of the windows to natural lighting, with reference to clauses 3.16.2 ⁽¹⁾ and 3.16.3 ⁽¹⁾ to this Standard. See section 10 of this Certificate.
Standard:	4.8(b)	Danger from accidents
Comment:		Where accidental collision is likely, glazing must comply with BS 6262-4 : 2005 to satisfy this Standard, with reference to clause 4.8.2 ⁽¹⁾⁽²⁾ . See section 12.2 of this Certificate.
Standard:	4.8(c)	Danger from accidents
Comment:		The products can be safely cleaned from inside the building, with reference to clause 4.8.3 ⁽¹⁾⁽²⁾ . See section 15.4 of this Certificate.
Standard:	6.1(a)(b)	Carbon dioxide emissions
Standard:	6.2	Building insulation envelope
Comment:		See sections 5.1 and 5.2 of this Certificate.
Regulation:	12	Building standards – conversions
Comment:		All comments given for these windows under Regulation 9, also apply to this Regulation, with reference to clause 0.12.1 ⁽¹⁾⁽²⁾ and Schedule 6 ⁽¹⁾⁽²⁾ . (1) Technical Handbook (Domestic). (2) Technical Handbook (Non-Domestic).



The Building Regulations (Northern Ireland) 2000 (as amended)

Regulation:	B2	Fitness of materials and workmanship
Comment:		The products are acceptable. See sections 16.1, 16.2, 16.5 and 16.6 and the <i>Installation</i> part of this Certificate.
Regulation:	B3(2)	Suitability of certain materials
Comment:		The products are acceptable. See sections 15.1 to 15.3 of this Certificate.
Regulation:	C4(b)	Resistance to ground moisture and weather
Comment:		The products will resist weather ingress. See sections 6.1 and 6.2 of this Certificate.
Regulation:	D1	Stability
Comment:		The products will have sufficient strength and stiffness to sustain the imposed loads. See sections 7.1 and 7.2 of this Certificate.
Regulation:	E2(c)	Means of escape
Comment:		Windows of an appropriate size can be used as an escape route in dwellings. See section 9.4 of this Certificate.
Regulation:	E3(a)	Internal fire spread – Linings
Comment:		The glazing used in the roof windows can be regarded as non-combustible material and therefore can be taken as having a Class 0 classification. See section 9.1 of this Certificate.
Regulation:	E5(b)	External fire spread
Comment:		When used in roof windows, unwired glass at least 4 mm thick can be regarded as having an AA designation. See section 9.2 of this Certificate.
Regulation:	F2(a)(i)	Conservation measures
Regulation:	F3	Target carbon dioxide Emissions Rate
Comment:		See sections 5.1 and 5.2 of this Certificate.
Regulation:	K2	Means of ventilation
Comment:		When calculating the area of window openings for ventilation purposes, see section 8.1 of this Certificate. Trickle ventilation is provided by the methods described in sections 8.2 and 8.3 of this Certificate.
Regulation:	V2	Impact with glazing
Comment:		Where people are likely to come into contact with glazing in a building the requirements of this Regulation shall be deemed to be satisfied if the glazing complies with Technical Booklet V, Section 2. See section 12.2 of this Certificate.
Regulation:	V4	Safe opening and closing of windows, skylights and ventilators
Comment:		Any window which can be opened by a person shall be so constructed or equipped that it may be opened, closed and adjusted safely. The requirements of this Regulation shall be deemed to be satisfied if the window complies with Technical Booklet V, Section 4. See section 12.1 of this Certificate.
Regulation:	V5	Safe means of access for cleaning glazing
Comment:		Reasonable provision shall be made for safe means of access to clean glazing. The requirements of this Regulation shall be deemed to be satisfied if the means of access complies with Technical Booklet V, Section 5. See section 15.4 of this Certificate.

Construction (Design and Management) Regulations 2007

Construction (Design and Management) Regulations (Northern Ireland) 2007

Information in this Certificate may assist the client, CDM co-ordinator, designer and contractors to address their obligations under these Regulations.

See section: 2 *Delivery and site handling* (2.4 and 2.5) of this Certificate.

Non-regulatory Information

NHBC Standards 2008

NHBC accepts the use of the Fakro FPP preSelect Top-hung Roof Windows, when installed and used in accordance with this Certificate in relation to *NHBC Standards, Chapter 6.7 Doors, windows and glazing*.

Zurich Building Guarantee Technical Manual 2007

In the opinion of the BBA the Fakro FPP preSelect Top-hung Roof Windows, when installed and used in accordance with this Certificate satisfy the requirements of the *Zurich Building Guarantee Technical Manual, Section 4 Superstructure, Sub-section External walls – doors, windows and roof lights* (page 172).

General

This Certificate relates to Fakro FPP preSelect Top-hung Roof Windows. The products comprise single-opening, top-hung roof windows which can also revolve about a centre pivot constructed from a wood core, covered in coil-coated aluminium covers on the external face, a clear water-based acrylic lacquer on the internal face and glazed with a sealed, double-glazed low emissivity, argon-filled unit with toughened glass.

The products are for use on roofs of domestic and commercial buildings with a pitch between 15° and 55°, to provide natural lighting and ventilation.

The products are manufactured by Fakro Sp. z.o.o. and marketed in the UK by Fakro (GB) Ltd, Fakro House, Astron Business Park, Heathcote Road, Swadlincote, Derbyshire DE11 9DW.
Tel: 01283 554755, Fax: 01283 224545.

Technical Specification

1 Description

1.1 Fakro FPP preSelect Top-hung Roof Windows (see Figure 1) are fabricated from preserved softwood frames and sashes featuring coil-coated aluminium covers on the external faces and clear, water-based acrylic lacquer on the internal faces of the frames and sashes.

1.2 The range comprises top-hung single-opening lights which can also revolve about a centre pivot subject to the size restrictions shown in Table 1.

Window code	Modular size width x height (mm)	Outer frame dimensions (mm)		Sash dimensions (mm)	
		Width	Height	Width	Height
04	660 x 1180	655	1179	570	1089
05	780 x 980	775	979	690	889
06	780 x 1180	775	1179	690	1089
07	780 x 1400	775	1399	690	1309
08	940 x 1180	935	1179	850	1089
09	940 x 1400	935	1399	850	1309
10	1140 x 1180	1135	1179	1050	1089
11	1140 x 1400	1135	1399	1050	1309

1.3 FPP preSelect roof windows are fitted with air inlet V40P and factory-glazed using sealed, double-glazed units (4/16/4). The units comprise a 4 mm thick outer pane made of toughened glass, a 16 mm argon-filled cavity and a 4 mm thick inner pane made of float glass featuring a low emissivity coating and carry CE Marking to show compliance with EN 1279-5 : 2005.

1.4 FPL preSelect roof windows are fitted with air inlet V40P and are factory-glazed using sealed, double-glazed units (4/14/6.4). The units comprise a 4 mm thick outer pane made of toughened glass, a 14 mm argon-filled cavity, a 6.4 mm thick inner pane made of laminated glass featuring a low emissivity coating and carry CE Marking to show compliance with EN 1279-5 : 2005.

1.5 The cores of the window framing members are profiled from softwood (either continuous timber or layer jointed material) and treated with preservative. Members of the outer frames and sashes are glued at the corners and additionally joined with quadruple and triple tenons respectively.

Figure 1 FPP preSelect Top-hung Roof Window cross-sections

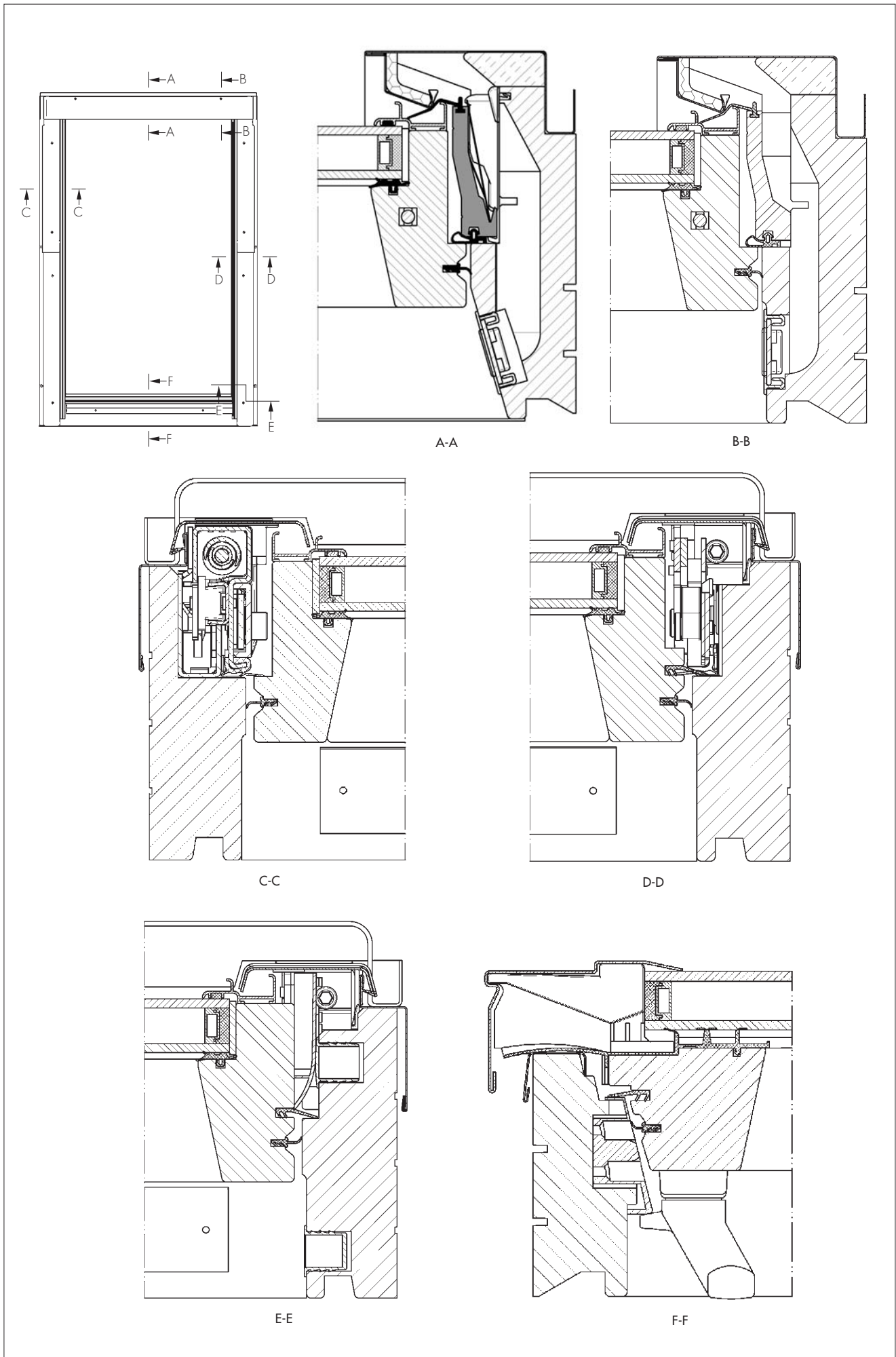

1.6 The aluminium profiles protecting the outer frame and sash and the flashings sealing the joint between the frame and the roof slope are extruded from aluminium sheet alloys type EN AW-1050 A to BS EN 573-3 : 2007 condition H44 to BS EN 515 : 1993. The aluminium sheet is 0.6 mm or 1.0 mm thick depending on component and meets the requirements of BS EN 485-1 : 2008 and is secured to the wood core with stainless steel screws.

1.7 The coil-coating on the aluminium components is available in RAL 7022 colour as standard (other colour finishes are an option) and has a thickness of 20 µm to 25 µm.

1.8 Glazing units are sealed into the wooden sash using Ethylene Propylene Diene Monomer (EPDM) gaskets conforming to DIN 7863 : 1983 on the inside and flexible butyl putty on the outside. The glazing unit is held with steel brackets. The profiles holding the glazing unit at the top and the jambs of the sash are made from aluminium alloy type EN AW-6060 to BS EN 573-3 : 2007 condition Thd T5 to BS EN 515 : 1993. The profiles holding the glazing unit at the bottom are extruded from aluminium sheet alloy EN AW-1050 A to BS EN 573-3 : 2007 condition H44 to BS EN 515 : 1993. The aluminium alloy profiles are coil-coated (thickness 20 µm to 25 µm).

1.9 Opening lights are operated by a handle positioned at the bottom member of the sash, constructed from anodized aluminium alloy with a polyester varnish. The top-hung and centre pivot hinges are constructed from zinc-coated galvanized steel. They allow the sash to be turned through 180° and secured in position by engaging one or two bolts (depending on window size) for cleaning and maintenance. A key-operated lock (or two depending on window size) is available and can be fitted at the bottom of the sash pivot.

1.10 TPE weatherstripping is located in the grooves around the periphery of the opening light frame below the hinge axis and around the outer frame above the hinge axis. The weatherstripping above the hinge axis is fixed using special cover strips screwed to the frame. The weatherstripping below the hinge axis is fixed to the jambs of the opening light, using cover strips screwed to the jambs. The weatherstripping is pressed into the special groove in the bottom member of the opening light and secured using stainless steel staples.

1.11 The windows are equipped with V40P hit and miss vents fitted in the top member of the outer frame. Vents are made from aluminium alloy type EN AW-6101 to BS EN 573-3 : 2007.

1.12 Quality control checks are carried out on the incoming materials, during production and on the finished products.

2 Delivery and site handling

2.1 The windows are delivered to site ready glazed. For transportation they are suitably protected in cardboard boxes to avoid damage.

2.2 Each window has a label bearing the company's mark and the BBA identification mark incorporating the number of this Certificate.

2.3 The windows should be stored under cover in a clean area, on edge and suitably supported to avoid distortion or damage.

2.4 The weight of the roof window, and its ease of handling, particularly by one person, must also be taken into account when planning site operations.

2.5 When selecting means of access, for example use of scaffolding, the safety of the operatives, the occupants, and the passers-by, during the period of installation, should be considered.

Assessment and Technical Investigations

The following is a summary of the assessment and technical investigations carried out on Fakro FPP preSelect Top-hung Roof Windows.

Design Considerations

3 Use

3.1 Fakro FPP preSelect Top-hung Roof Windows are suitable for use on roofs of domestic or commercial buildings with a pitch between 15° and 55°.

3.2 New roof structures incorporating the product should be designed and constructed in accordance with the relevant Building Regulations and British (or European) Standards.

3.3 The roof windows are suitable for most existing roofs and for replacing existing roof windows. For such installations, it is important that the roof is checked by a suitably-qualified person for structural adequacy and strengthened as required to support the additional loads imposed upon it by the installation of the roof windows.

4 Practicability of installation

The products are designed to be installed by a competent general builder, or a contractor, experienced with this type of product.

5 Thermal insulation

 5.1 The thermal transmittance value (U value) of an FPP preSelect roof window, 1137 mm wide by 1400 mm high, incorporating a top-hung opening light and glazed with a 4/16/4 mm sealed, double-glazed unit: Silverstar ENplus as the inner pane [low-E soft coating of emissivity (ϵ_n) = 0.03 (declared value)], argon-filled cavity and TGI spacers, when measured by the Guarded Hot Box Method according to BS EN ISO 12567-2 : 2005, is $1.4 \text{ Wm}^{-2}\text{K}^{-1}$. In the opinion of the BBA the thermal transmittance value (U value) of an FPL preSelect roof window, incorporating a 6 mm laminated inner pane but otherwise identical, would be similar.

5.2 For the purposes of heat loss calculations, the U value measured in section 5.1 should be adjusted according to the slope of installation in accordance with Section 11.1 of BRE Report (BR 443 : 2006) *Conventions for U-value calculations*.

6 Weathertightness

 6.1 When installed in accordance with the Certificate holder's instructions and sections 17 and 18, the windows will provide a weatherproof construction.

6.2 Selected samples from the windows were tested to BS EN 14351-1 : 2006. Results were classified in accordance with BS EN 12207 : 2000, BS EN 12208 : 2000 and BS EN 12210 : 2000 (see Table 2). The gradings are based on the assumption that the outer frame is supported in accordance with the manufacturer's instructions.

6.3 For unusual building layouts, building shapes or ground topography, the designer will need to give particular consideration to the prevailing exposure conditions.

Table 2 Test pressure class

	Classification to		
	BS EN 12207	BS EN 12208	BS EN 12210
Air permeability ⁽¹⁾	Class 4		
Watertightness ⁽¹⁾		Class E1050	
Wind resistance ⁽¹⁾			Class C5/B5

(1) Window tested in the vertical position.

7 Structural stability

 7.1 The products achieve the wind resistance loads shown in Table 2.

7.2 The magnitude of the actual snow load imposed will depend upon a number of factors, such as height above sea level, geographical location and roof arrangement. Therefore, it is recommended that BS 6399-3 : 1988 is used to calculate the actual snow load.

7.3 Details of connections between the roof window and the roof must be entrusted to a suitably-qualified person. Guidance is available from the Certificate holder or its agent.

8 Ventilation

 8.1 The approximate opening area for rapid natural ventilation is given in Table 3.

8.2 Contribution to the background ventilation requirements of the various Building Regulations can be made by the adjustable trickle vents incorporated in the roof windows.

8.3 The equivalent areas of the vent (see Figure 2) are given in Table 3.

Table 3 Ventilation areas

Window code	Opening area for rapid ventilation (m ²)	Equivalent area for trickle ventilation (mm ²) ⁽¹⁾ Vent V40P
04	0.62	1820
05	0.61	2548
06	0.75	2548
07	0.90	2548
08	0.92	2730
09	1.11	2730
10	1.15	3640
11	1.38	3640

(1) Based on an equivalent area of 182 mm² per vent's aperture.

Figure 2 Vent



8.4 The vents' geometric area will be greater than the figures shown in Table 3, however the integral mesh makes a determination impractical. Users in Scotland and Northern Ireland should therefore take the relevant equivalent area in Table 3, when considering requirements for minimum geometric area.

9 Behaviour in relation to fire



9.1 The glazing used in the windows is Class A1 by reference to Commission Decision 96/603/EC and can therefore be considered as non-combustible.



9.2 When used in roof windows, unwired glass at least 4 mm thick can be regarded as having an AA designation.



9.3 When used in roof windows, glass at least 4 mm thick is classified as 'low vulnerability' material.



9.4 Where a window is required, in a dwelling (for England and Wales and Scotland dwellings with a floor not more than 4.5 m above ground level), to provide a means of escape from an inner room or a loft space converted into a habitable room, the window can meet the relevant Requirements or Standards of the national Building Regulations when it incorporates an opening light positioned no more than 1.1 m above the floor, providing a clear opening area of at least 0.33 m² (the obstruction caused by opening lights hung on top-hung or pivot hinges must be taken into account when the clear opening is determined) and not less than 450 mm high by 450 mm wide. The route through the window may be at an angle rather than straight through. In addition:

England and Wales — windows must remain open without needing to be held.

Scotland — locks may be used but must not cause a permanent obstruction to satisfy clause 2.9.4⁽¹⁾ as escape windows.

(1) Technical Booklet (Domestic).

Northern Ireland — the window must be positioned not less than 600 mm above the floor.

9.5 It is recommended that windows must remain open without needing to be held, where this is not a regulatory requirement.

10 Glass area



The approximate glass area of the windows is given in Table 4.

Table 4 Approximate glass area

Window code	Glass area (m ²)
04	0.47
05	0.47
06	0.59
07	0.72
08	0.75
09	0.92
10	0.94
11	1.16

11 Condensation risk

 Experience of window systems similar to Fakro FPP preSelect Top-hung Roof Windows has shown that, in normal domestic or similar applications, roof windows do not constitute a significant condensation risk when correctly installed. Guidance on some satisfactory design details is given in TSO, 2002 *Limiting thermal bridging and air leakage : Robust construction details for dwellings and similar buildings*. Further information is contained in BRE Report (BR 262 : 2002) *Thermal insulation : avoiding risks*.

12 Safety

 12.1 The windows can comply with the recommendations of BS 8213-1 : 2004 with regard to the positioning of hand-operated controls.

 12.2 Account must be taken of the recommendations given in BS 6262-4 : 2005, which include the use of safety glass, complying with BS EN 12600 : 2002, under certain circumstances.

13 Security against intrusion

13.1 The opening lights are fitted with a lock mechanism as described in section 1.9. When fastened in the closed position, the opening light cannot be opened by manipulation from the outside, for example, by the insertion of a thin blade. The opening lights can be fitted with a key-operated locking device, where the windows are required to satisfy the security requirements of *NHBC Standards 2007*, Chapter 6.7 *Doors, windows and glazing* and the *Zurich Building Guarantee Technical Manual 2007*, Section 4 *Superstructure*, Sub-section *External walls – doors, windows and roof lights* (page 175). It is the responsibility of the building designer to specify where these requirements need to be satisfied.

13.2 The arrangement of the aluminium cladding and glazing retaining profiles with screw fixings ensures that removal of the glass is difficult from the outside.

14 Ease of operation

The windows can be operated without difficulty when correctly installed.

15 Maintenance

 15.1 The windows can be re-glazed and the gaskets, putty and weatherstripping replaced, but these operations are outside the scope of this Certificate.

15.2 Maintenance painting of the external and internal finishes should be considered if a high aesthetic standard is required (see sections 16.2 and 16.4). The Certificate holder can recommend a suitable paint and maintenance system (outside the scope of this Certificate).

15.3 If damage occurs, the furniture and fittings can be replaced.

 15.4 The external pane of the glazing unit can be cleaned from inside the building.

15.5 The glazing and external frame members can be cleaned using water containing household detergent. If dirt is allowed to build up on the members over long periods it may become more difficult to restore the surface appearance.

15.6 Care should be taken when using proprietary materials for cleaning the glass, to ensure that deposits are not allowed to remain on the wood or aluminium surfaces where they may cause discoloration and damage to the surface. In addition, care must be taken to avoid damage to, or discoloration of, the members when stripping paint from adjacent timber, for example, by means of a blowlamp or paint stripper.

15.7 The hinges and locking mechanism should be lubricated periodically to minimise wear and to ensure smooth operation.

16 Durability



16.1 The windows are constructed from preservative-treated softwood, which is protected externally by aluminium covers. Therefore, the life of the roof windows is expected to be at least equal to conventional timber windows.

16.2 The performance of the external coating will depend on its environment, location and aspect face. It will retain a good appearance for at least 15 years.

16.3 Any external colour change or surface dulling of the aluminium covers that might occur will be uniform over any one elevation.

16.4 The appearance of the acrylic internal finish may be reduced in areas of high humidity such as kitchens or bathrooms or if subjected to mechanical damage. The appearance can be restored by overcoating.



16.5 Fittings, including the hinges and locking handles will have similar durability except where windows are to be installed in areas subject to particularly aggressive conditions. These conditions can prevail in coastal locations or near sources of industrial pollutants and replacement of fittings may be necessary within the life of the window.

16.6 The gaskets and weatherstripping may need to be replaced within the life of the window.

Installation

17 General

17.1 Fakro FPP preSelect Top-hung Roof Windows must be fixed into the opening, in accordance with the recommendations in the *Fakro Catalogue Fitting Instructions*, using angled anchors, made from zinc-coated, galvanized steel, fixed to the window frame and rafters or battens. The window may be installed at any point above floor level (subject to Building Regulations approval), but consideration must be given to ease of operation. See Figure 3 for typical installations.

Figure 3 Typical window placements

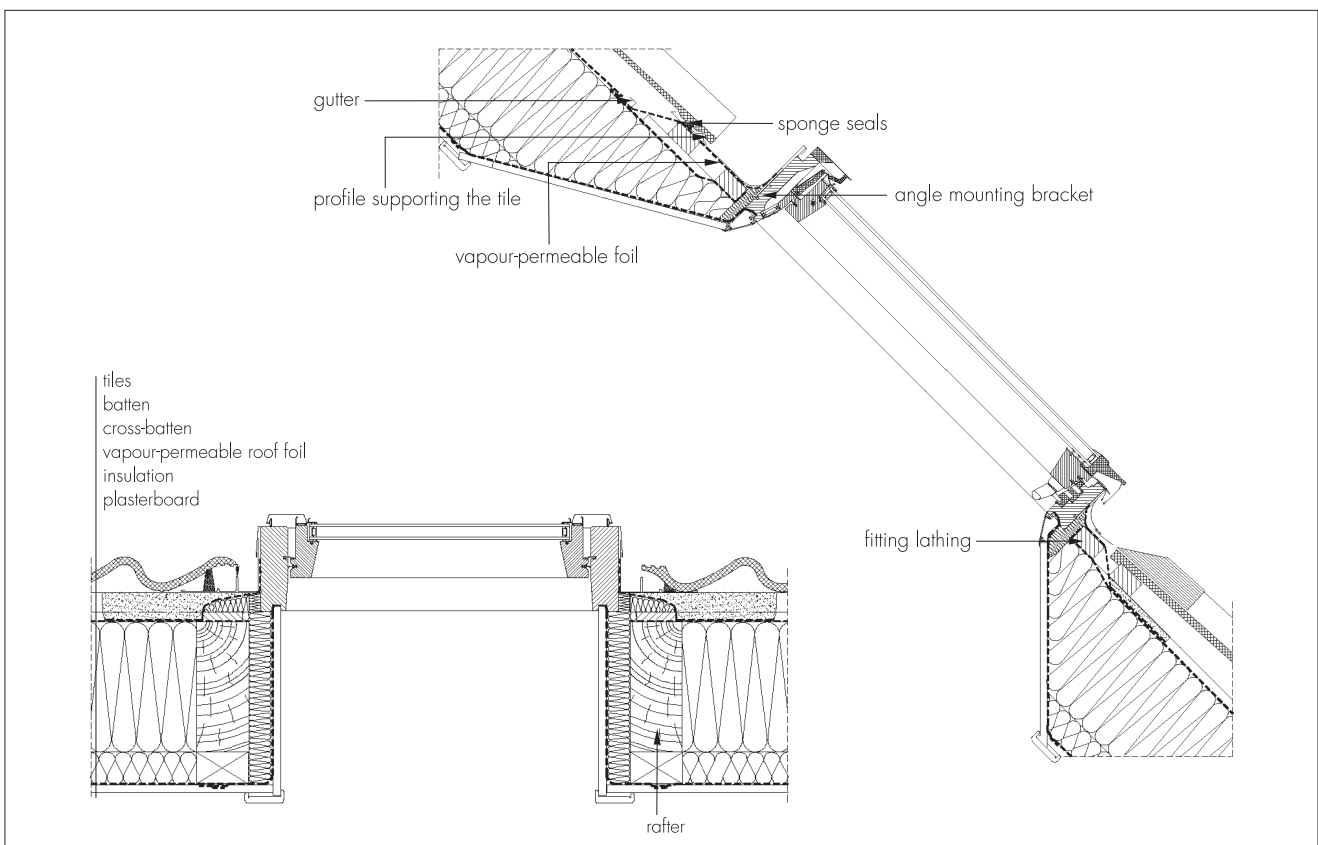

17.2 With suitable propping, it is normally acceptable to cut out one rafter and form a trimmed opening. Where more extensive cutting of structural members is proposed or in any case of doubt, appropriately qualified and experienced persons should be consulted.

17.3 When preparing the opening to accept the roof window, a tolerance of 5 mm to 10 mm should be allowed.

17.4 The window must be installed above a complete row of tiles or slates, as these must not be cut under the window. In the case of metal roof sheets or similar, the window must be installed above a horizontal lap. In the case of corrugated roof sheets or high profile tiles or slates, it is recommended that the upper edge of the roofing material is cut (tiles or slates) or flattened (metal roof sheets or similar) under the edge of the window.

17.5 When installing the window, the following distances between the edge of the window and tiles must be maintained:

- at bottom edge of window 0 to 40 mm for flat tiles (up to 5 mm thick, eg slates)
 20 to 100 mm for tiles (over 5 mm and up to 15 mm thick)
 80 to 100 mm for tiles up to 45 mm thick
 90 to 120 mm for tiles/corrugated sheets up to 90 mm thick
- at sides of window 30 to 60 mm
- at top edge of window 60 to 150 mm

17.6 The window aperture should be marked on the roofing felt. When cutting away the roofing material a 100 mm flap should be allowed all around to provide a waterproof damp-proof membrane (dpm). The battens are cut out where the window is to be fitted. A roof gutter is installed above the position of the window after cutting out a section of counter batten, if installed, and cutting the felt diagonally.

17.7 The window is fitted using four angle brackets or six brackets for windows over 1400 mm high. The optimum spacing between the rafters should be close to the width of the window and can be 20 mm to 50 mm larger than it. In the case of a roof having a different spacing between the rafters, or if the roof is constructed on bidding rafters, additional timber support must be provided.

17.8 The battens or roof boarding is cut, where the window is to be fitted, to the width of the window plus 20 mm to 50 mm and to the height of the window plus 20 mm to 40 mm.

18 Procedure

Preparation of the window

18.1 The opening light frame and the side mounting supports are removed and the lower support is unscrewed from the casing in accordance with the manufacturer's instructions.

18.2 The supplied angle mounting brackets are fixed to the jambs of the outer frame approximately 100 mm from the corners in accordance with the manufacturer's instructions.

Mounting the window on the roof

18.3 The casing is fitted into the prepared opening in the roof ensuring that it lies horizontally using a spirit level.

18.4 The lower angle brackets are screwed onto the rafters or battens and the opening light frame is fitted into the casing in accordance with the manufacturer's instructions and the top angle brackets are screwed onto the rafters.

18.5 The roof tile underlay/dpc is secured around the perimeter of the roof window.

18.6 Installation is completed by fixing the appropriate flashings in accordance with the manufacturer's instructions.

Technical Investigations

19 Tests

19.1 Tests were carried out by IFT Rosenheim to BS EN 14351-1 : 2006 and ITB to determine:

- air permeability
- watertightness
- effect of wind loads
- efficiency of window fittings
- loadbearing capacity of safety devices (BS EN 14609 : 2004).

19.2 The thermal transmittance value of an FPP preSelect window was measured using the Guarded Hot Box Method.

19.3 Additional test work in accordance with BS 6375-2 : 1987 was carried out by the BBA to determine:

- mechanical loading
- ease of operation.

19.4 The air vent was tested in accordance with BS EN 13141-1 : 2004.

20 Investigations

The manufacturing process and the window fabrication procedure including, in each case, the methods adopted for quality control, have been examined and found satisfactory by the ITB and CSTB.

Bibliography

BS 6262-4 : 2005 *Glazing for buildings — Code of practice for safety related to human impact*

BS 6375-2 : 1987 *Performance of windows — Specification for operation and strength characteristics*

BS 6399-3 : 1988 *Loading for buildings — Code of practice for imposed roof loads*

BS 8213-1 : 2004 *Windows, doors and rooflights — Design for safety in use and during cleaning of windows, including door-height windows and roof windows — Code of practice*

BS EN 485-1 : 2008 *Aluminium and aluminium alloys — Sheet, strip and plate — Technical conditions for inspection and delivery*

BS EN 515 : 1993 *Aluminium and aluminium alloys — Wrought products — Temper designations*

BS EN 573-3 : 2007 *Aluminium and aluminium alloys — Chemical composition and form of wrought products — Chemical composition and form of products*

BS EN 12207 : 2000 *Windows and doors — Air permeability — Classification*

BS EN 12208 : 2000 *Windows and doors — Watertightness — Classification*

BS EN 12210 : 2000 *Windows and doors — Resistance to wind load — Classification*

BS EN 12600 : 2002 *Glass in building — Pendulum test — Impact test method and classification for flat glass*

BS EN 13141-1 : 2004 *Ventilation for buildings — Performance testing of components/products for residential ventilation — Externally and internally mounted air transfer devices*

BS EN 14351-1 : 2006 *Windows and doors — Product standard, performance characteristics — Windows and external pedestrian doorsets without resistance to fire and/or smoke leakage characteristics*

BS EN 14609 : 2004 *Windows — Determination of the resistance to static torsion*

BS EN ISO 12567-2 : 2005 *Thermal performance of windows and doors — Determination of thermal transmittance by hot box method — Roof windows and other projecting windows*

DIN 7863 : 1983 *Non cellular elastomer glazing and panel gaskets; technical delivery conditions*

EC Decision 96/603/EC — *Commission Decision of 4 October 1996 establishing a list of products belonging to Class A — No contribution to fire*

EN 1279-5 : 2005 *Glass in building — Insulating glass units — Evaluation of conformity*

Conditions of Certification

21 Conditions

21.1 This Certificate:

- relates only to the product/system that is named and described on the front page
- is granted only to the company, firm or person named on the front page — no other company, firm or person may hold or claim any entitlement to this Certificate
- is valid only within the UK
- has to be read, considered and used as a whole document — it may be misleading and will be incomplete to be selective
- is copyright of the BBA
- is subject to English law.

21.2 Publications and documents referred to in this Certificate are those that the BBA deems to be relevant at the date of issue or re-issue of this Certificate and include any: Act of Parliament; Statutory Instrument; Directive; Regulation; British, European or International Standard; Code of Practice; manufacturers' instructions; or any other publication or document similar or related to the aforementioned.

21.3 This Certificate will remain valid for an unlimited period provided that the product/system and the manufacture and/or fabrication including all related and relevant processes thereof:

- are maintained at or above the levels which have been assessed and found to be satisfactory by the BBA
- continue to be checked as and when deemed appropriate by the BBA under arrangements that it will determine
- are reviewed by the BBA as and when it considers appropriate.

21.4 In granting this Certificate, the BBA is not responsible for:

- the presence or absence of any patent, intellectual property or similar rights subsisting in the product/system or any other product/system
- the right of the Certificate holder to manufacture, supply, install, maintain or market the product/system
- individual installations of the product/system, including the nature, design, methods and workmanship of or related to the installation
- the actual works in which the product/system is installed, used and maintained, including the nature, design, methods and workmanship of such works.

21.5 Any information relating to the manufacture, supply, installation, use and maintenance of this product/system which is contained or referred to in this Certificate is the minimum required to be met when the product/system is manufactured, supplied, installed, used and maintained. It does not purport in any way to restate the requirements of the Health & Safety at Work etc Act 1974, or of any other statutory, common law or other duty which may exist at the date of this Certificate; nor is conformity with such information to be taken as satisfying the requirements of the 1974 Act or of any statutory, common law or other duty of care. In granting this Certificate, the BBA does not accept responsibility to any person or body for any loss or damage, including personal injury, arising as a direct or indirect result of the manufacture, supply, installation, use and maintenance of this product/system.